

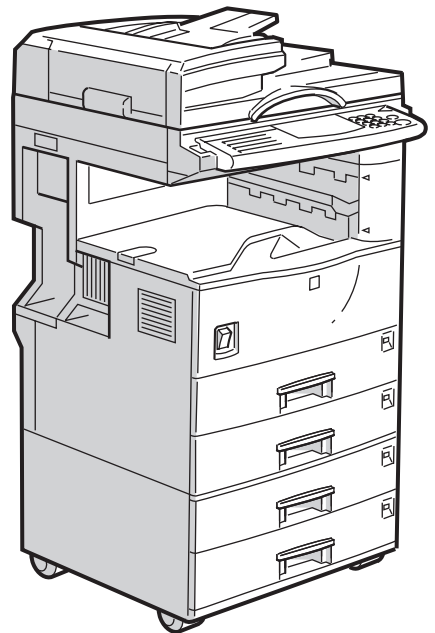

Scanner Option Type270

OPERATING INSTRUCTIONS SCANNER REFERENCE(option)



Read this manual carefully before you use this product and keep it handy for future reference.

For safety, please follow the instructions in this manual.



OPERATING INSTRUCTIONS



Printed in Japan

EE 

UE  A844-8541

Introduction

This manual contains detailed instructions on the operation and maintenance of this machine. To get maximum versatility from this machine all operators should carefully read and follow the instructions in this manual.

Please read the Safety Information in the "Copy Reference" before using this machine. It contains important information related to USER SAFETY and PREVENTING EQUIPMENT PROBLEMS.

Important

Parts of this manual are subject to change without prior notice. In no event will the company be liable for direct, indirect, special, incidental, or consequential damages as a result of handling or operating the machine.

Trademarks

Microsoft® and Windows® are registered trademarks of Microsoft Corporation in the United States and/or other countries.

Ethernet® is a registered trademark of Xerox Corporation.

Note to users in the United States of America

Notice:

This equipment has been tested and found to comply with the limits for a Class B digital device, pursuant to Part 15 of the FCC Rules. These limits are designed to provide reasonable protection against harmful interference in a residential installation. This equipment generates, uses and can radiate radio frequency energy and, if not installed and used in accordance with the instructions, may cause harmful interference to radio communications. However, there is no guarantee that interference will not occur in a particular installation. If this equipment does cause harmful interference to radio or television reception, which can be determined by turning the equipment off and on, the user is encouraged to try to correct the interference by one more of the following measures:

Reorient or relocate the receiving antenna.

Increase the separation between the equipment and receiver.

Connect the equipment into an outlet on a circuit different from that to which the receiver is connected.

Consult the dealer or an experienced radio /TV technician for help.

Warning

Changes or modifications not expressly approved by the party responsible for compliance could void the user's authority to operate the equipment.

Caution

Properly shielded and grounded cables and connectors must be used for connections to host computer (and/or peripheral) in order to meet FCC emission limits.

Declaration of conformity

Product Name: Scanner Option

Model Number: Type270

Responsible party: Ricoh Corporation

Address: 5 Dedrick Place, West Caldwell, NJ 07006

Telephone number: 973-882-2000

This device complies with part 15 of FCC Rules.

Operation is subject to the following two conditions:

1. This device may not cause harmful interference, and
2. this device must accept any interference received, including interference that may cause undesired operation.

Note to users in Canada

Warning:

This Class B digital apparatus meets all requirements of the Canadian Interference-Causing Equipment Regulations.

Remarque concernant les utilisateurs au Canada

Avertissement:

Cet appareil numérique de la classe B respecte toutes les exigences du Règlement sur le matériel brouilleur du Canada.

In accordance with IEC 60417, this machine uses the following symbols for the main power switch:

I means POWER ON.

O means POWER OFF.



Declaration of Conformity

"The Product complies with the requirements of the EMC Directive 89/336/EEC and the Low Voltage Directive 73/23/EEC."

Energy Star Program

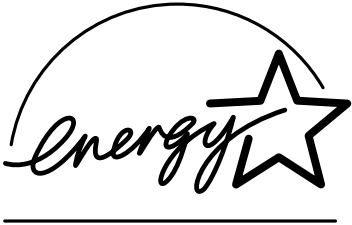
<p>ENERGY STAR®</p> 	<p>As an ENERGY STAR Partner, we have determined that this machine model meets the ENERGY STAR Guidelines for energy efficiency.</p>
---	--

The ENERGY STAR Guidelines intend to establish an international energy-saving system for developing and introducing energy-efficient office equipment to deal with environmental issues, such as global warming.

When a product meets the ENERGY STAR Guidelines for energy efficiency, the Partner shall place the ENERGY STAR logo onto the machine model.

This product was designed to reduce the environmental impact associated with office equipment by means of energy-saving features, such as Low-power mode.

- **Low Power mode**
 This product automatically lowers its power consumption 15 minute after the last operation has been completed. To exit Low-power mode, follow one of the procedures below.
 - Place or remove originals from the Document Table.
 - Open or close the Auto Document Feeder(ADF).
 - Begin scanning operation from the host computer.
 The machine returns to the ready condition in about 20 seconds.
 For how to change the default interval before entering Low-power mode, see System Setting Reference.

❖ **Specification**

		Fax, printer and scanner installed	
		Type 1	Type 2
Low Power mode	Power consumption	120 wh	
	Default interval	15 minutes	
	Recovery time	Less than 20 seconds	

How to Read this Manual

Symbols

In this manual, the following symbols are used:

 **WARNING:**

This symbol indicates a potentially hazardous situation that might result in death or serious injury when you misuse the machine without following the instructions under this symbol. Be sure to read the instructions, all of which are described in the Safety Information section.

 **CAUTION:**

This symbol indicates a potentially hazardous situation that might result in minor or moderate injury or property damage that does not involve personal injury when you misuse the machine without following the instructions under this symbol. Be sure to read the instructions, all of which are described in the Safety Information section.

* The statements above are notes for your safety.

 **Important**

If this instruction is not followed, paper might be misfed, originals might be damaged, or data might be lost. Be sure to read this.

 **Preparation**

This symbol indicates the prior knowledge or preparations required before operating.

 **Note**

This symbol indicates precautions for operation, or actions to take after misoperation.

 **Limitation**

This symbol indicates numerical limits, functions that cannot be used together, or conditions in which a particular function cannot be used.

 **Reference**

This symbol indicates a reference.

[]

Keys that appear on the machine's panel display.

【 】

Keys built into the machine's operation panel.

TABLE OF CONTENTS

1. Preparation

Features	2
Network TWAIN Scanner	2
Network Delivery Scanner.....	3
Confirming the Scanner Network Interface	5
Connecting to the Network	6
Indicators.....	6

2. Setting Up the Scanner

Setting Items	7
Setting Up the Network Environment	9
Network Setting Items	11
Setting Up the Scanner	14
Scanner Settings.....	16

3. Installing the driver

Features	19
Environments	20
Installing/Uninstalling Type270 TWAIN Driver Ver.2	21
Using Windows 95/98	21
Using WindowsNT4.0.....	23
Using Windows NT 3.51.....	24

4. Basic Operation

Using as a scanner	25
Changing to Scanner Mode	25
Interrupting scanning.....	25
Setting Originals on the Exposure Glass (Platen Glass)	27
Setting Originals in the Document Feeder (ADF)	28
1-sided Scanning	29
2-sided Scanning	30

5. Appendix

Troubleshooting	31
The Copier Error Messages	32
Image Data Setting Error Messages	32
Copier Error Messages	33
Network Delivery Scanner Error Messages	33

- Type270 TWAIN Driver Ver.2 Error Messages 35**
 - Image Data Setting Error Messages 35
 - Scanning Operation Error Messages 35
 - Copier Error Messages 36
 - Other Error Messages 36
- Status Messages 38**
- System Settings..... 39**
 - Accessing the User Tools (System Settings) 39
 - Settings You Can Change with the User Tools 40
- Relationship Between Resolution and Scanning Area..... 41**
 - Binary / Halftone..... 41
 - Gray Scale 43
- When Using DHCP..... 45**
 - Supported Systems 45
 - Configuring the scanner with a Reserved IP Address..... 45
- Assigning an IP Address with ARP+PING 46**
- Specifications 47**
- INDEX..... 48**

1. Preparation

This machine can be used as a network scanner by installing Scanner Option Type270. The network scanner has two functions: the “Network Delivery Scanner” and the “Network TWAIN Scanner”.

This chapter provides necessary information on the features and the best environment for this machine.

Note

- You can add the Network Delivery Scanner function using ScanRouter which comes with the machine to deliver scanned images to clients on the network.
- This manual mainly explains how to use the Network TWAIN Scanner function. For more information on the operation and configuration settings of the Network Delivery Scanner function, see the manual that comes with ScanRouter.

Features

1

Network TWAIN Scanner

The Network TWAIN Scanner allows clients on the network to use the scanner as if the scanner were connected directly to the clients.

The illustration shows the following procedure: client C sends a message to the machine to scan the originals, and then the scanned image is returned to client C.

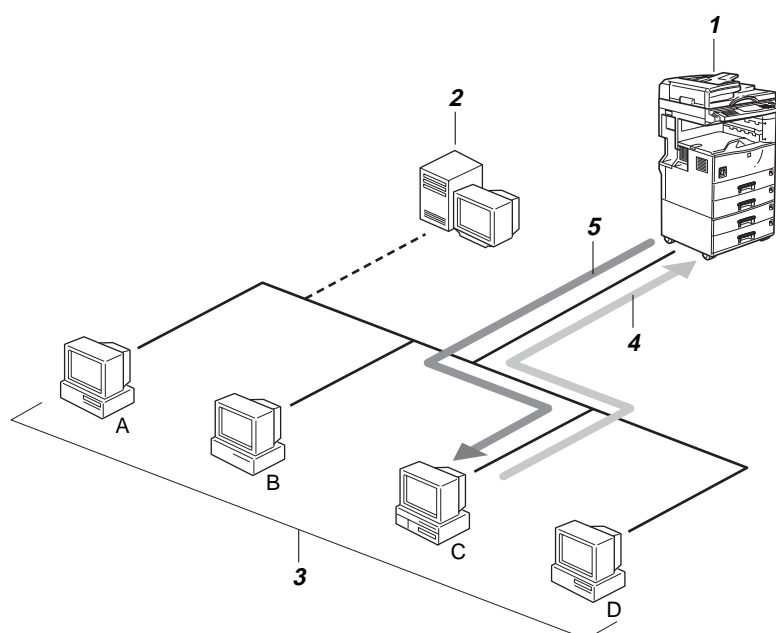

ZATX500J

1. scanner
2. ScanRouter Station
3. clients
4. scanning command
5. scanned data

Note

- Confirm that the client computers and the scanner unit are on the same local network segment. Client computers cannot be connected to the scanner unit located on a different local network segment.
- To use the Network TWAIN Scanner to scan originals, follow these steps.

① Setting originals

Set originals on the exposure glass (platen glass) or in the document feeder (ADF).

⇒ P.27 "Setting Originals on the Exposure Glass (Platen Glass)"

⇒ P.28 "Setting Originals in the Document Feeder (ADF)"

② Configuring the scanner settings from a network client

Start Type270 TWAIN Driver Ver.2 from the application using the TWAIN driver, and then configure the scanner settings.

③ Starting the scan

Type270 TWAIN Driver Ver.2 starts scanning.

Network Delivery Scanner

The Network Delivery Scanner is made available when ScanRouter is installed. You can deliver scanned data from the scanner to a selected client among pre-registered clients.

It is also possible to deliver scanned data to multiple clients at the same time.

The following illustration shows how scanned data is delivered to clients A and B at the same time.

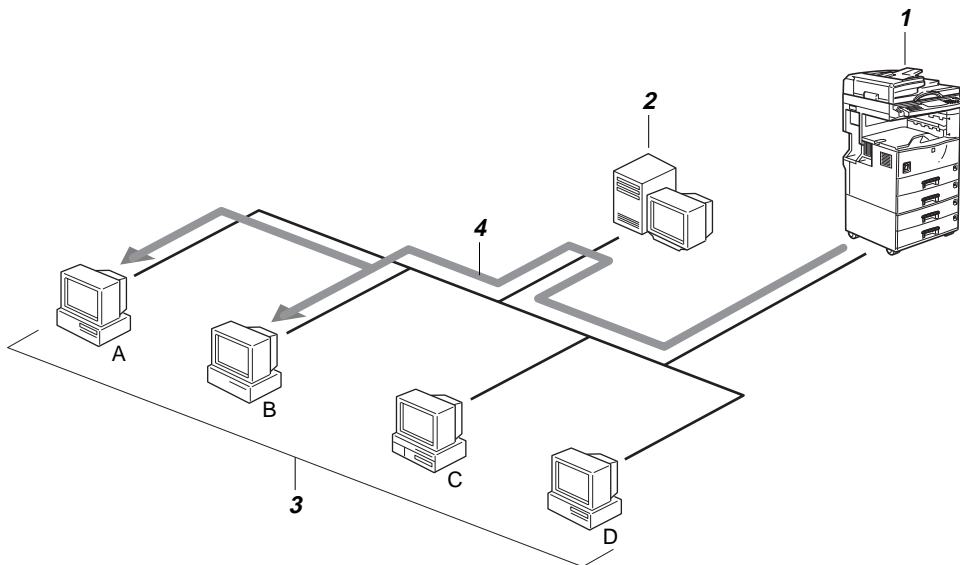

ZATX510J

1. scanner**2. ScanRouter Station****3. clients****4. scanned data**

To deliver scanned data to a client using the Network Delivery Scanner, follow the procedure below.

For more information on operating the Network Delivery Scanner, see the manual that comes with ScanRouter.

 **Note**

The first four steps can be done in any order.

① Selecting the receiver

Use the operation panel to set the address of the client that will receive scanned data.

② Selecting the sending client computer

Use the operation panel to set the address of the client that will deliver scanned data.

③ Configuring the scanner settings

Use the operation panel to configure the scanner settings.

④ Setting originals

Set originals on the exposure glass (platen glass) or in the document feeder (ADF).

⇒ P.27 "*Setting Originals on the Exposure Glass (Platen Glass)*"

⇒ P.28 "*Setting Originals in the Document Feeder (ADF)*"

⑤ Starting the scan

The scan starts.

Confirming the Scanner Network Interface

This scanner unit is installed on the left side of the Scanner Network Interface Board (as shown in the illustrations).

The network interface of this scanner unit supports 10BASE-T and 100BASE-TX (one of which is detected automatically).

1

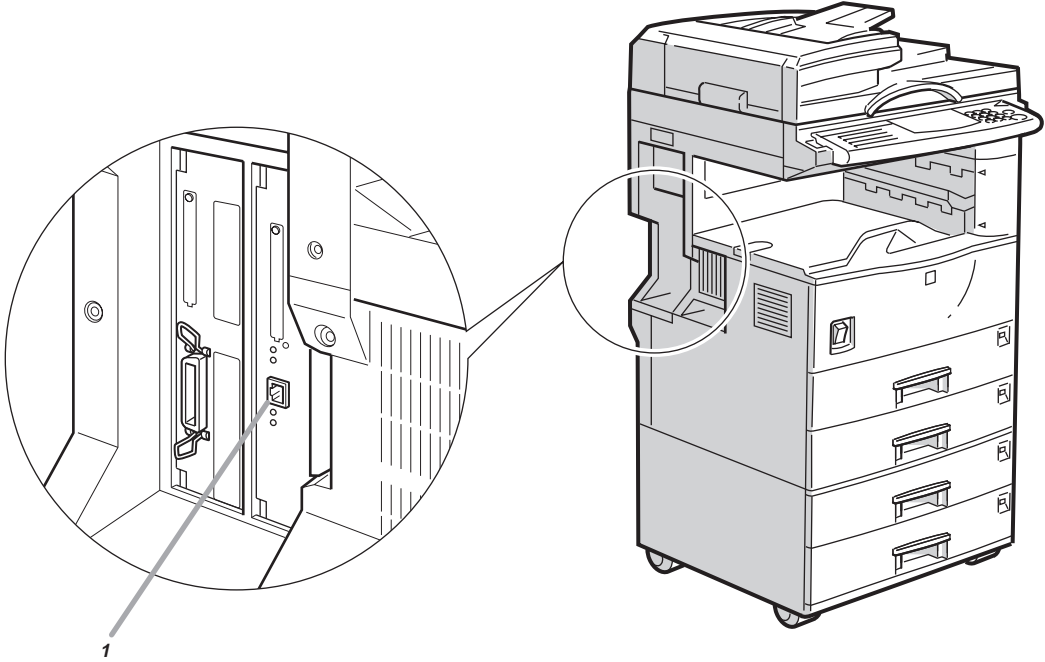

ZATH500E

Optional equipment is installed in this illustration.

1. Scanner unit interface network connector

Connecting to the Network

1

This scanner unit and the network are connected using 10BASE-T or 100BASE-TX network interface cable.

- 1** Confirm that the main power switch is off.
- 2** Loop the network interface cable twice. The loops should be about 15cm (6inch) from the end of the cable on the end closest to the connector.
- 3** Attach the ferrite core to the loops.

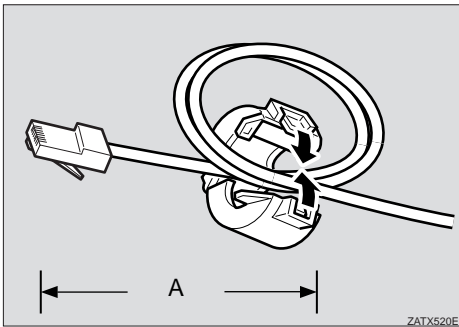

A=15cm (6inch)

- 4** Connect the main scanner unit to the network hub using the network cable.

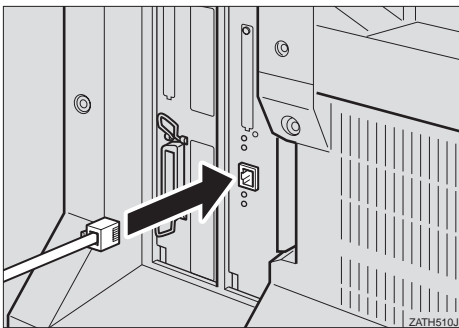

- 5** Turn on the main power switch.

Note

- The default IP address is "011.022.033.044". Change the IP address in accordance with the environment you are using. For more information on changing the IP address, see P.9 "Setting Up the Network Environment".

Indicators

There are four LED indicators on the scanner unit. They can be used to confirm that the board is working properly.

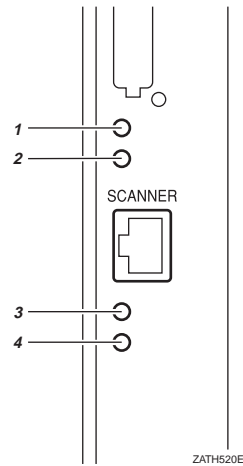

- 1. Indicator (red)**
Is on while the network is working.
- 2. Indicator (orange)**
Is on while the Network Interface Board is working.
- 3. Indicator (green)**
Is on while using 100BASE-TX. Is off while using 10BASE-T.
- 4. Indicator (green)**
Is on while the machine is in a network environment.

2. Setting Up the Scanner

Setting Items

This chapter explains the settings necessary to use the machine as a network scanner.

To use the machine as the Network TWAIN Scanner or Network Delivery Scanner, the following three initial settings are required: network Settings, image data settings and scanner settings.

- ★ indicates the settings required to use the machine as a network scanner. Confirm that all these settings are configured before using the machine.
- ☆ indicates the settings required depending on the environment. Configure the settings appropriate to the environment you are using.

	Items	Default	TWAIN *1	Delivery *2
Network Settings	Scanner IP Address	011.022.033.044	★	★
	Subnet Mask	000.000.000.000	☆	☆
	Gateway Address	000.000.000.000	☆	☆
	Access Control (Access Control Address)	000.000.000.000	☆	
	Access Mask (Access Control Mask)	000.000.000.000	☆	
	Network Boot	NONE	☆	☆
	Delivery Server Address	000.000.000.000		★
	Mac Address *3	-		
ImageData Settings	Density	4		★
	Scan type	Text		★
	Resolution	100dpi		★
	Scan size	Auto Detect		★

	Items	Default	TWAIN *1	Delivery *2
Scanner Settings	Function Priority	Delivery		☆
	TWAIN connection time out.	Off		☆
	Scanner Auto Clear Time	Off		☆
	Date	-		☆
	Compression (Black & White)	On	☆	☆
	Compression(Gray Scale)	Standard	☆	☆
	Delivery option	Not Installed		★
	Auto Address Update	On		★
	Measurement Unit	mm		★

*1 Settings required for the Network TWAIN Scanner
 *2 Settings required for the Network Delivery Scanner
 *3 The setting value is displayed. However, you cannot change it.

 **Note**

- This chapter explains the network settings and the scanner settings necessary for using the Network TWAIN Scanner.
- To use the Network Delivery Scanner, the image data settings must be configured. For more information, see the manual that comes with ScanRouter.

Setting Up the Network Environment

This section explains how to set up the network environment and configure essential settings. For more information on setting values, see P.11 “Network Setting Items”.

Important

- Consult your network administrator for help with these settings.

1 Press [User Tools/Counter].

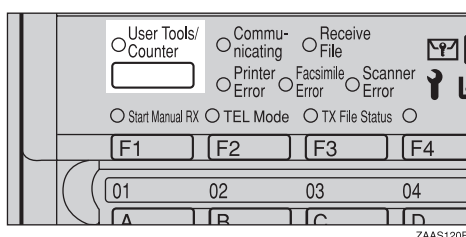

The following message appears.

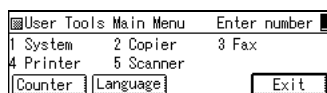

Limitation

- While scanning, delivering, printing or copying, pressing [User Tools/Counter] does not cause the message to change to User Tools Main Menu.

2 Press [5] on the number keys.

3 Press [Network].

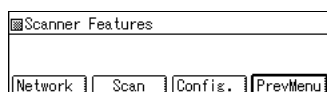

4 Press [↑Prev.] or [↓Next] until the following message appears.

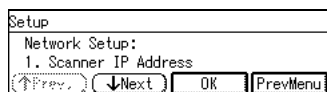

Note

- When canceling the current settings, press [PrevMenu] twice, and then press [Exit].

5 Press [OK].

- If you press [OK] after selecting “2. Subnet Mask” in step 4, the following message appears. When this occurs, you can change the setting by entering the desired numerical values.

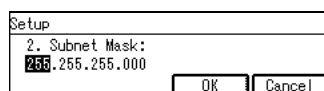

- If you press [OK] after selecting “6. Network Boot” in step 4, the following message appears. “*” (asterisk) is displayed with the current settings. When this occurs, you can change the setting by selecting the items.

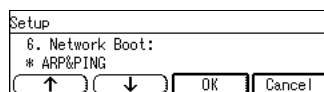

6 Start settings.

- When entering numerical values, use the number keys. If you press [#] after entering numerical values, you can continue to the next column. ⏪ or ⏩ are also available to change the input position.
- When selecting items, press ⏪ or ⏩ to navigate through the items to be configured on the panel display.

Note

- See P.11 “Network Setting Items” for detail settings.

- When canceling the current settings, press **[Cancel]**. Without changing the numerical values, the previous screen is displayed.

7 Press **[OK]**.

Changed values are saved and the message displayed in step **4** appears.

Note

- From this screen, you can also configure other network settings.

8 Press **[PrevMenu]**.

The message displayed in step **3** appears.

Note

- Using this message, you can also make the network settings and the image data settings.

9 Press **[PrevMenu]**.

The message displayed in step **1** appears.

10 Press **[Exit]**.

The changed settings are saved, and the message before the settings were made appears.

Important

- After pressing **[Exit]**, do not turn off the machine until the main menu is displayed, otherwise, the settings will not be applied.

Note

- Changed settings cannot be saved until you press **[Exit]**. These settings also cannot be saved if the power is turned off before **[Exit]** is pressed.
- If you press **[User Tools/Counter]** while navigating the message screens, changed settings will not be saved.

Network Setting Items

Required network settings are as follows. Make settings appropriate to your network environment.

Items	Default	TWAIN ^{*1}	Delivery ^{*2}
1. Scanner IP Address	011.022.033.044	★	★
2. Subnet Mask	000.000.000.000	☆	☆
3. Gateway Address	000.000.000.000	☆	☆
4. Access Control (Access Control Address)	000.000.000.000	☆	
5. Access Mask (Access Control Mask)	000.000.000.000	☆	
6. Network Boot	NONE	☆	☆
7. Delivery Server Address ^{*3}	000.000.000.000		★
8. Mac Address ^{*4}	-		

^{*1} Settings required for the Network TWAIN Scanner

^{*2} Settings Required for the Network Delivery Scanner

^{*3} You cannot configure this setting if "No" is configured for the "7. Delivery option" of "Scanner Settings".

^{*4} The setting value is displayed. However, you cannot change it.

❖ Scanner IP Address

This is the IP address of this scanner on the network. It is essential that the IP address be entered.

Set the address as follows: xxx.xxx.xxx.xxx (xxx: for any numerical value from 0–255)

Note

- Do not assign the same IP address to two or more machines on the same network. If two or more machines on the network have the same IP address, the machine will not work. To confirm the address, contact your network administrator.

❖ Subnet Mask

This sets a part of the IP address as the network address. Use a subnet mask if the network uses subnets. Set the mask values as follows: xxx.xxx.xxx.xxx (xxx: for any numerical value from 0–255)

Note

- If you do not know the mask values, use the default setting.

❖ **Gateway Address**

This is the address of the router or host computer used as the gateway. Set it up if you want to use the machine from a client in a different network. Set the mask values as follows: xxx.xxx.xxx.xxx (xxx: for any numerical value from 0–255)

 **Note**

- If you do not know the gateway address, use the default setting.

❖ **Access Control Address and Access Control Mask**

The access control address and the access control mask are used to limit the clients that have access to the scanner on the basis of their IP addresses. They are inseparable, and therefore, if one is configured, the other must also be configured at the same time.

- The access control address uses an IP address to set the clients that can access the scanner.
- The access control mask is used with the access control address to set a range of IP addresses that can access the scanner.

Set the address as follows: xxx.xxx.xxx.xxx (xxx: for any numerical vale from 0–255)

 **Note**

- If you do not want to limit access to the machine, use the default settings.
- When the access control address settings coincide with the masked result of the IP address of the computer, scanning jobs from that client's IP address can be accepted by the network interface.
- For example, if you assign 192.168.15.16 as the access control address to the Network Interface Board, the combination of the access control mask and IP Addresses that can have access are as follows. (xxx: for any numerical value from 0–255)

Access Control Mask	IP Addresses that have access
000.000.000.000	xxx.xxx.xxx.xxx
255.000.000.000	192.xxx.xxx.xxx
255.255.000.000	192.168.xxx.xxx
255.255.255.000	192.168.15.xxx
255.255.255.255	192.168.15.16

❖ Network Boot

This selects the way in which the client can set the IP address of the scanner. The default setting is “NONE”. To change it, consult your network administrator, and make new settings appropriate for your network environment. The settings you can select are as follows.

Menu Items on the Panel Display	Available Method			
	AR ^{*1}	RA ^{*2}	BO ^{*3}	DH ^{*4}
None (Default Setting)				
ARP&PING	☆			
RARP&TFTP		☆		
BOOTP			☆	
RARP&BOOTP		☆	☆	
ARP&RARP	☆	☆		
ARP&BOOTP	☆		☆	
ARP&RARP&BOOTP	☆	☆	☆	
DHCP				☆

*1 ARP+PING

*2 RARP+TFTP

*3 BOOTP

*4 DHCP

Note

- If you want to use “RARP + TFTP”, “BOOTP” or “DHCP”, you must configure the server.
- When selecting DHCP, assign the scanner a fixed IP address. ⇒ P.45 “When Using DHCP”

❖ Delivery Server Address

This is the server IP address used to deliver the scanned originals to a client on the network. Set this address when you use the machine as a Network Delivery Scanner. Set the address as follows: xxx.xxx.xxx.xxx (xxx: for any numerical value from 0–255)

Note

- To get the delivery server IP address for the scanner, contact your network administrator.

❖ Mac Address

You can confirm the MAC address of the scanner unit installed in the machine. The MAC address has already been assigned for each machine, and therefore, cannot be changed.

⇒ P.45 “When Using DHCP”

⇒ P.46 “Assigning an IP Address with ARP+PING”

Setting Up the Scanner

This section explains how to set up the scanner and how to configure essential settings. For more information on the setting values, see P.16 “Scanner Settings”.

2

1 Press **[User Tools/Counter]**.

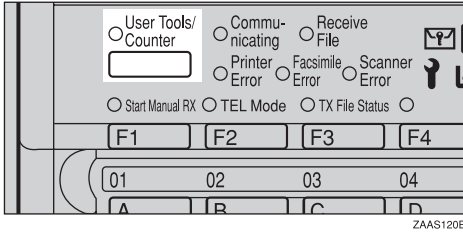

The following message appears.



! Limitation

- When scanning, delivering, printing or copying, pressing **[User Tools/Counter]** does not cause the message to change to User Tools Main Menu.

2 Press **[5]** on the number keys.

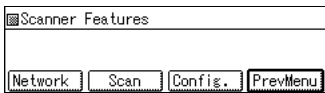

3 Press **[Config.]**.

4 Press **[↑Prev.]** or **[↓Next]** until the following message appears.

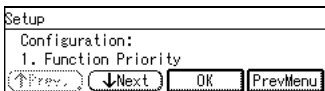

Note

- When canceling the current settings, press **[PrevMenu]** twice, and then press **[Exit]**.

5 Press **[OK]**.

- If you press **[OK]** after selecting “4.Date” in step **4**, the following message appears. When this occurs, you can change the setting by entering the desired numerical values.

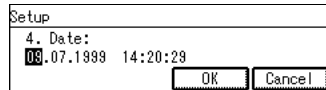

- If you press **[OK]** after selecting “5.Compression(Black & White)” in step **4**, the following message appears. “*” (asterisk) is displayed with the current settings. When this occurs, you can change the settings of the items.



6 Start settings.

- When entering numerical values, use the number keys. If you press **[#]** after entering numerical values, you can continue to the next column. **[←]** or **[→]** can also be used to change the input position.
- When selecting items, press **[↑]** or **[↓]** to select items indicated on the panel.

Note

- See P.16 “Scanner Settings” for additional information on the settings.
- When canceling the current settings, press **[Cancel]**. The previous screen appears and changed values will not be saved.

7 Press **[OK]**.

Changed values are saved and the message displayed in step **4** appears.

 **Note**

- From this screen, you can also configure other network settings.

8 Press **[PrevMenu]**.

The message displayed in step **3** appears.

 **Note**

- From this screen, you can configure the network settings and the image data settings.

9 Press **[PrevMenu]**.

The message displayed in step **1** appears.

10 Press **[Exit]**.

Changed settings are saved, and the message before settings were made appears.

 **Important**

- After pressing **[Exit]**, do not turn off the machine until the main menu is displayed, otherwise, the settings will not be applied.

 **Note**

- Changed settings cannot be saved until you press **[Exit]**. These settings also cannot be saved if the power is turned off before **[Exit]** is pressed.
- If you press **[User Tools/Counter]** while navigating the message screens, changed settings will not be saved.

Scanner Settings

Required scanner settings are as follows. Configure settings appropriate to your network environment.

Items	Default	TWAIN ^{*1}	Delivery ^{*2}
1. Function Priority	Delivery		☆
2. TWAIN connection time out.	Off		☆
3. Scanner Auto Clear Time ^{*3}	Off		☆
4. Date	—		☆
5. Compression(Black & White)	On	☆	☆
6. Compression(Gray Scale)	Standard	☆	☆
7. Delivery option	Not Installed		★
8. Auto Address Update	Off		★
9. Measurement Unit	mm		★

^{*1} Setting required for the Network TWAIN Scanner

^{*2} Setting required for the Network Delivery Scanner

^{*3} You cannot configure this setting if "Not Installed" is configured for the "7. Delivery option" of the "Scanner Settings".

❖ Function Priority

Select "TWAIN" or "Delivery " to use Network TWAIN Scanner mode or Network Delivery Scanner mode by pressing **[Scanner]** on the operation panel. The default setting is "Delivery".

Note

- When selecting "TWAIN" and pressing **[Scanner]**, the mode switches to Network TWAIN Scanner mode. You can switch to Network Delivery Scanner mode by pressing **[Cancel]**.
- When Selecting "Delivery " and pressing **[Scanner]**, the mode switches to Network Delivery Scanner mode. Remember that you cannot do the opposite (that is, switch from Network Delivery Scanner mode to Network TWAIN Scanner mode.) If you want to use the machine as a Network TWAIN Scanner, access the machine from the computer which will scan the originals.

Important

- After changing settings, turn the power off and then on again. If this is not done, the settings will not be applied.

❖ **TWAIN connection time out.**

You can set the duration to switch the mode from “Delivery ” to “TWAIN” while using the machine as a Network Delivery Scanner when other clients are accessing the machine to scan originals as a Network TWAIN Scanner.

- If you select “Off”, you can switch to the Network TWAIN Scanner immediately.
- When selecting “On”, input the disconnect duration time (3-30 seconds) with the number keys.

The default setting is “Off”.

❖ **Scanner Auto Clear Time**

When selecting a receiver, a sender or image data settings using Network Delivery Scanner mode, if you do not input anything for a certain amount of time, the command you have made will be cleared.

- When selecting "On", use the number keys to enter the length of time (10-999 seconds) the machine waits before clearing the settings.
- If "Off" is selected, the settings will not be cleared.

The default setting is "Off".

❖ **Date**

Set the current date and time. Enter the information in the following sequence with the number keys: year (four digits), month, day, hour (24 hour style), minute and second.

Note

- The date set here is for clients who use the machine as a Network Delivery Scanner to see the length of time that is needed to scan originals.

❖ **Compression(Black & White)**

You can configure whether or not the transmitted data is to be compressed. Compression allows data to be sent to the computer in less time. Select “On” or “Off”. The default setting is “On”.

Note

- Compression is for reducing the amount of time used to deliver the image to the computer, and not for compressing the scanned image.
- The amount of time required to send the data depends on the amount of data and the network conditions.

❖ **Compression(Gray Scale)**

You can configure the amount of compression applied to scanned gray scale data. Compression allows data to be sent to the personal computer in less time.

The default setting is “Standard ”.

 **Note**

- Compression is for reducing the amount of time used to send the image to the computer, and not for compressing the scanned original image.
- Lower compression rates require more time to transfer, from lower to highest, "Low" "Standard " "High " and "Off".
- The amount of time required to send the data depends on the amount of data and the network conditions.

❖ Delivery option

This setting is necessary to use the machine as a Network Delivery Scanner with ScanRouter installed. When you set the Delivery Option to "Installed", the following settings are available. When you set the Delivery Option to "Not Installed", these settings are not available.

- Network Settings "7.Delivery Server Address"
- Scanner Settings "1.Function Priority", "2.TWAIN connection time out.", "3.Scanner Auto Clear Time", "8.Auto Address Update", "9.Measurement Unit".

The default setting is "Not Installed".

 **Important**

- After changing settings, turn the power off, then on again. If this is not done, the new settings will not be applied.

❖ Auto Address Update

When using the machine as a Network Delivery Scanner, you can use this function to automatically update the address book (the lists of addresses and senders).

- When selecting "On", pressing **[Address]** while in Network Delivery Scanner mode, the address saved in the machine is compared with the one saved in the ScanRouter Station, and then it will be updated.
- When selecting "Off", only when you turn on the power, the address is updated.

The default setting is "On".

❖ Measurement Unit

You can set the unit of measurement that is shown on the operation panel when scanning originals by selecting the area to be scanned with Network Delivery Mode.

Select "mm" or "inch".

The default setting is "mm".

3. Installing the driver

Features

The drivers (provided in the CD-ROM labeled Type270 for TWAIN Driver for Scanner Option Type270) allow you to use this machine with the installed scanner unit through the network. To use the machine as a network scanner, Type270 TWAIN Driver Ver.2 is required. A Web Browser used for monitoring the scanner unit on the network is also included in the CD-ROM.

This chapter provides necessary information on the features and environment required to use and install/uninstall the driver. This chapter also includes information on using a Web Browsers to monitor the scanner on a network.

Type270 TWAIN Driver Ver.2

This driver allows you to scan originals with a scanner. Be sure to install this driver before using the scanner unit.

The driver can also provides the following functions: compounding written rows, such as those of date and page numbers, and adjusting the slant of letters.

⇒ P.21 *“Installing/Uninstalling Type270 TWAIN Driver Ver.2”*

Note

- Type270 TWAIN Driver Ver.2 is included in the CD-ROM in the following directory:

`\Driver\TWAIN\`

Configuring the Network Interface Board with a Web Browser

You can use a Web browser to view the printer and scanner status through the network. If the computer is connected to the network and is configured to use a web browser, you can use this function without being affected by the OS of the computer. You do not need to install any additional applications to use this function.

Note

- For more information, see the Online Help that is included in the CD-ROM in the following directory:

`\help\wsmhlp\`

- You can also use PRINTER MANAGER FOR CLIENT to view the status of this scanner unit. In addition, you can use PRINTER MANAGER FOR ADMIN to set up the scanner unit. However, this setting is not available when the scanner unit is in Energy Saver mode.
- PRINTER MANAGER is included in the CD-ROM that comes with the printer. For more information on PRINTER MANAGER, see the manual that comes with the Network Interface Board.

Environments

To use Type270 TWAIN Driver Ver.2, the following hardware and software environments are required.

❖ Personal Computer

75MHz or faster Intel Pentium CPU (200MHz or faster recommended)

The computer must have a CD-ROM drive. (The driver is provided in a CD-ROM.)

❖ OS

Windows 95/98 or Windows NT 4.0/3.51

Note

Windows 3.1x is not supported.

❖ Memory

Windows 95/98: 16MB or more (48MB or more recommended)

Windows NT4.0/3.51: 24MB or more (64MB or more recommended)

❖ Display

Requires SVGA (800×600) supporting 256 colors or more.

❖ Hard Disk

100MB of hard disk space (100MB or more recommended) are required for the installation, save and preview image files.

❖ Ethernet Board

It must be compatible with Windows 95/98 or Windows NT4.0/3.51 environments.

Note

The Ethernet board does not work if it is not recognized in the Windows 95/98 or Windows NT 4.0/3.51 environments.

❖ Ethernet Cable

Use category 5 STP cabling with an RJ-45 connector.

❖ Network Protocol

TCP/IP

❖ TWAIN Compliant application

An application compliant to TWAIN 1.6 or later must be installed.

Note

If you are not sure that the application you are using is compliant to TWAIN 1.6 or later, contact the manufacturer of the application.

Installing/Uninstalling Type270 TWAIN Driver Ver.2

To use this scanner unit, Type270 TWAIN Driver Ver.2 must be installed. Installation differs depending on Windows 95/98, Windows NT 4.0 or Windows NT 3.51. Install the driver in accordance with the OS you are using.

When you reinstall Type270 TWAIN Driver Ver.2, or when it becomes unnecessary, uninstall the driver in accordance with the OS you are using.

Important

- If Type 450 TWAIN Driver is installed, uninstall it first, and then install Type270 TWAIN Driver Ver.2.

Using Windows 95/98

Preparation

Before installation, confirm that the computer you are using is configured to use the TCP/IP, by selecting "Configuration" in "Network" from **[Control Panel]**.

Installing

When using Windows 95/98, follow these steps.

1 Insert the CD-ROM into the CD-ROM drive.

A set up program starts automatically and the **[welcome]** appears.

Reference

In case a set up program does not start automatically, see P.22 "Starting the Setup Program".

2 Read the message on the screen carefully, and then click **[Next]**.

The **[Software License Agreement]** appears.

3 Read the message on the screen carefully. If you agree, click **[Yes]**. **[Select Program Folder]** appears.

4 Read the message on the screen carefully. If you agree, click **[Next]**.

Usually, you do not need to change the program folder.

Installation starts, and **[Setup Complete]** is appears when it is completed.

Note

- During installation, if the dialog box appears asking you to confirm that you want to rewrite the pre-installed files, click **[Yes]**.

5 Confirm the message on the screen, and then click **[Finish]**.

Select **[Yes, I want to restart my computer now.]**.

Note

- If the screen message asking if you want to restart your computer does not appear in step **5**, click **[Finish]**.
- When restarting Windows by installing this driver, the message of "WINASPI has been replaced the old version" might be displayed. In this case, click **[Ignore]**.

Starting the Setup Program

If the setup program does not start automatically after inserting Type270 TWAIN Driver Ver.2 and Utilities, follow these steps.

1 To open [Add/Remove Programs], double-click the [my computer] icon, and then double-click [Control Panel].

The [Add/Remove Program Properties] dialog box appears.

2 Click [Install/Uninstall], and then click [Install] (for Windows 98) or [Setup] (for Windows 95).

[Install Programs From Floppy Disk or CD-ROM] appears.

3 Click [Next].

4 Type the name of the CD-ROM drive in the command line, followed by "\Driver\TWAIN\othersSetup.exe" (do not include the quotation marks), and then click [OK].

 **Note**

- An example would be "\Driver\TWAIN\othersSetup.exe" when the drive letter is "D".

Installation starts.

When Finishing Installation

After installation, "Type270 TWAIN Driver Ver.2", "Help Files" and "Readme.txt" are registered.

❖ **Help Files**

Help Files is a help system that contains information on the operational process to scan an image and configuring the image data settings using Type270 TWAIN Driver Ver.2.

❖ **Readme.txt**

Readme.txt contains information on using Type270 TWAIN Driver Ver.2. Be sure to read it before using them.

Uninstalling

When Type270 TWAIN Driver Ver.2 is no longer needed, uninstall it. You can delete Type270 TWAIN Driver Ver.2 and other related files from the hard disk. When reinstalling Type270 TWAIN Driver Ver.2, uninstall it first, and then reinstall it.

 **Note**

- When uninstalling, the setting values file is not deleted.

1 To open [Add/Remove Programs], double-click the [my computer] icon, and then double-click [Control Panel].

The [Add/Remove Program Properties] dialog box appears.

2 Click [Type270 TWAIN Driver Ver.2] and click [Add/Remove].

A dialog box appears to confirm cancellation.

3 Read the message on the screen carefully. If you agree, click [Yes].

Uninstallation starts.

4 When [Uninstall successfully] is displayed below the dialog box, click [OK].

The dialog box closes.

Using WindowsNT4.0

Preparation

Before installation, confirm that the computer you are using is configured to use the TCP/IP, by selecting "Protocol" in "Network" from **[Control Panel]**.

Note

- To install the Type270 TWAIN Driver Ver.2, you must be logged on as a member of the Administrators group.

Installing

1 Insert the CD-ROM into the CD-ROM drive.

A setup program starts automatically and **[welcome]** dialog box appears.

Reference

If the setup program does not start automatically, see P.22 "*Starting the Setup Program*".

2 Read the message on the screen carefully. If you agree, click **[Next]**.

The **[Software License Agreement]** appears.

3 Read the message on the screen carefully. If you agree, click **[Yes]**. **[Select Program Folder]** appears.

4 Read the message on the screen carefully. If you agree, click **[Next]**.

Usually, you do not need to change the program folder.

Installation starts, and **[Setup Complete]** is displayed when it is completed.

5 Confirm the message on the screen, and then click **[Finish]**.

Select **[Yes, I want to restart my computer now.]**.

Note

- If the screen message asking if you want to restart your computer does not appear in step **5**, click **[Finish]**.
- Readme.txt contains information on using Type270 TWAIN Driver Ver.2. Be sure to read it before using them.

Uninstalling

When Type270 TWAIN Driver Ver.2 is no longer needed, uninstall it. You can delete Type270 TWAIN Driver Ver.2 and other related files from the hard disk. When reinstalling Type270 TWAIN Driver Ver.2, uninstall it first, and then reinstall it.

Note

- When uninstalling, the setting values file is not deleted.

1 To open **[Add/Remove Programs]**, double-click the **[my computer]** icon, and then double-click **[Control Panel]**.

The **[Add/Remove Program Properties]** dialog box appears.

2 Click **[Type270 TWAIN Driver Ver.2]** and then click **[Add/Remove]**.

A dialog box appears to confirm cancellation.

3 Read the message on the screen carefully. If you agree, click **[Yes]**.

Uninstallation starts.

4 When **[Uninstall successfully]** is indicated below the dialog box, click **[OK]**.

The dialog box closes.

Using Windows NT 3.51

Preparation

Before installation, confirm that the computer you are using is configured to use the TCP/IP, by selecting "Network Settings" in "Network" from **[Control Panel]**.

Note

- To install the Type270 TWAIN Driver Ver.2, you must be logged on as a member of the Administrators group.

Installing

1 Insert the CD-ROM into the CD-ROM drive.

2 Open **[File Manager]**.

3 From the file menu, click **[Run...]**.
[Run] appears.

4 Type the name of the CD-ROM drive in the command line, followed by "`\Driver\TWAIN\othersSetup.exe`" (do not include the quotation marks), and then click **[OK]**.

Note

- An example would be "`\Driver\TWAIN\othersSetup.exe`" when the drive letter is "D".

[welcome] appears.

5 Read the message on the screen carefully, and then press **[Next]**.
[Software License Agreement] appears.

6 Read the message on the screen carefully. If you agree, click **[Yes]**.
[Select Program Folder] appears.

7 Read the message on the screen carefully. If you agree, click **[Next]**.

Usually, you do not need to change the program folder.

Installation starts, and **[Setup Complete]** is indicated when it is completed.

8 Confirm the message on the screen, and then click **[Finish]**.

Select **[Yes, I want to restart my computer now.]**.

Note

- If the screen message asking if you want to restart your computer does not appear in step **8**, click **[Finish]**.
- Readme.txt that is installed in the Type270 TWAIN Driver Ver.2(common) in the program manager contains information on using Type270 TWAIN Driver Ver.2. Be sure to read it before using them.

Uninstalling

When Type270 TWAIN Driver Ver.2 is no longer needed, uninstall it. You can delete Type270 TWAIN Driver Ver.2 and other related files from the hard disk. When reinstalling Type270 TWAIN Driver Ver.2, uninstall it first, and then reinstall it.

Note

- When uninstalling, the setting values file is not deleted.

1 Double-click the **[Uninstall]** icon from the Type270 TWAIN Driver Ver.2 group in the program manager.

2 From now, follow the instructions displayed on the screen.

4. Basic Operation

Using as a scanner

Changing to Scanner Mode

This scanner unit has two scanner functions: "Network TWAIN Scanner" and "Network Delivery Scanner".

Reference

To configure the function priority, see P.16 "Scanner Settings".

Limitation

- In the following cases, the machine cannot be used as a scanner.
 - While scanning originals for copying
 - While scanning a fax message for transmission
 - During immediate fax transmission

Using the Network TWAIN Scanner

- 1** Set originals.
- 2** Configure the scan options using the computer.
- 3** Start the scan.

Reference

For more information, see Type270 TWAIN Driver Ver.2 help.

Using the Network Delivery Scanner

- 1** Press **[Scanner]**.

The screen for the scanner mode appears.

- 2** Set originals.

- 3** Set the scan options, an address and a sender.

- 4** Press **[Start]**.

Reference

For more information, see the ScanRouter reference.

Interrupting scanning

If you want to scan while copying or faxing, follow the procedure below.

Scanning while copying

Usually, you cannot use this machine as a scanner until it finishes copying.

Preparation

Select P.40 "System Settings" "05.Function Reset" to set "Instant".

- 1** Press **[Clear/Stop]**.

Copying is interrupted.

- 2** Remove the originals.

- 3** Press **[Reset]**.

- 4** Start the scan.

Note

- When the scan is completed, press **[Copy]** and restart copying.

Scanning while scanning a fax message for memory transmission

Usually, you cannot use the scanner function until scanning a fax message for memory transmission is completed.

 **Preparation**

Select P.40 "System Settings" "05.Function Reset" to set "Instant".

1 Press **[Clear/Stop]**.

The fax message scan is interrupted.

 **Note**

- While using the quick memory delivery, previously scanned originals will be delivered.

2 Remove the originals.

3 Start the scan.

 **Note**

- When the scan is completed, press **[Facsimile]** and restart faxing.

Scanning while doing an Immediate Fax Transmission

Usually, you cannot use the scanner function while it is doing an immediate fax transmission.

 **Preparation**

Select P.40 "System Settings" "05.Function Reset" to set "Instant".

1 Press **[Clear/Stop]**.

The immediate fax transmission is interrupted.

 **Note**

- Previously scanned originals will be delivered.

2 Remove the originals.

3 Start the scan.

 **Note**

- When the scan is completed, press **[Facsimile]** and restart faxing.

Scanning while printing

You can scan without interrupting printing.

Setting Originals on the Exposure Glass (Platen Glass)

The exposure glass (platen glass) can be used when scanning originals that cannot be set in the document feeder (ADF), such as books or originals that have been pasted together. These types of originals will be referred to as “book originals”. Follow the procedure below to set originals on the exposure glass (platen glass).

- 1** Lift the platen cover or the document feeder (ADF), and place the original face down on the exposure glass (platen glass).

Attach the paper at the reference mark.

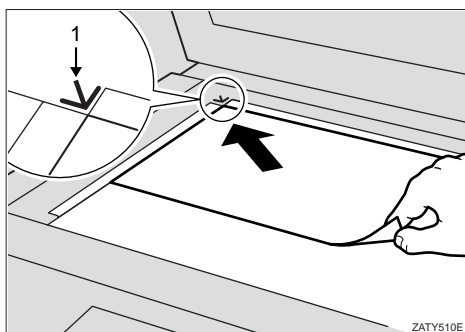

1. Reference mark

Important

- Set the original after correction fluid and ink has completely dried. Not taking this precaution could mark the exposure glass (platen glass) and cause marks to be copied.

Note

- Set the original in the direction shown in the illustration. The direction of resulting scan is as follows.

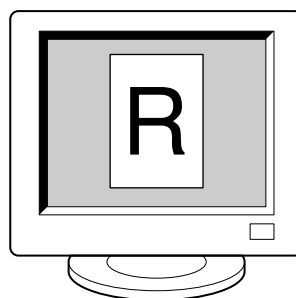
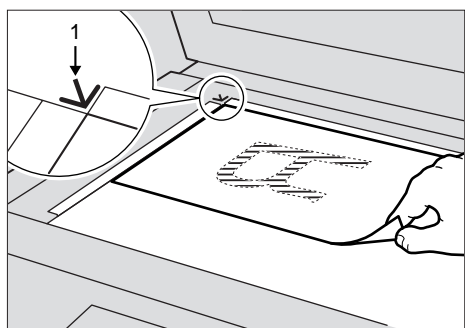

ZATY520E

1. Reference mark

- 2** Lower the platen cover or the document feeder (ADF).

Setting Originals in the Document Feeder (ADF)

You can set several pages of originals in the document feeder (ADF) at a time. Only originals that consist of separate sheets of paper can be set in the document feeder (ADF); these originals will be called “sheet originals”. It is possible to copy not only one side but both sides of originals that are set in the document feeder (ADF).

Note

- The document feeder (ADF) is optional. Preparation is required to use this optional document feeder (ADF).

❖ Non-recommended originals for the document feeder

For more information on recommended and non-recommended originals for the document feeder (ADF), see the “Copy Reference”.

Important

- When using the scanner unit, you cannot set the following types of originals in addition to the types of the originals that you cannot use for the copy function in the document feeder (ADF).
 - Originals that are smaller than A5.
 - Originals that are longer than the long-edge of Double Letter
- Setting non-recommended originals in the document feeder (ADF) might cause paper misfeeds or damage to the originals. Set these originals on the exposure glass (platen glass).

❖ Setting Originals in the Document Feeder

- Do not stack originals above the limit mark.
- When copying thin originals (41–52g/m² 11–14lb), set the originals on the exposure glass (platen glass) to avoid damage due to a multi-sheet feed (if several sheets are fed together at the same time).
- When irregular size originals that are longer than A4 or Letter are loaded, a paper misfeed may occur in the document feeder (ADF).
- For information on the automatically detected original size, see the “Copy Reference”.

Note

- The automatically detected original size differs depending on Metric/Inch version.

1-sided Scanning

- 1 Set the originals into the document feeder (ADF) with the side to be scanned face up.

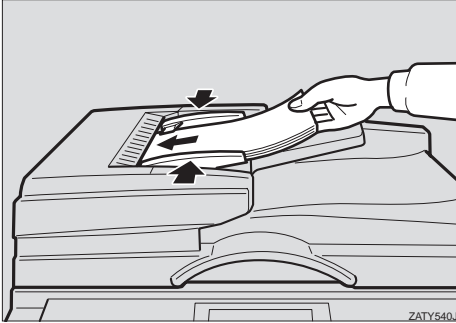

Note

- ❑ The sheets of the original should be ordered in the preferred page sequence.

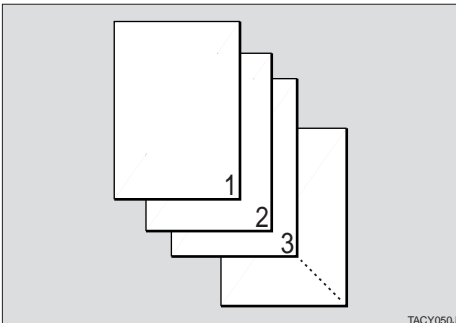

- ❑ To avoid a multi-sheet feed (in which the ADF feeds through more than one sheet at a time), shuffle the pages of the original before setting them in the document feeder (ADF).
- ❑ Set the original with the same direction as shown in the illustration. The direction of the resulting scan is as follows.

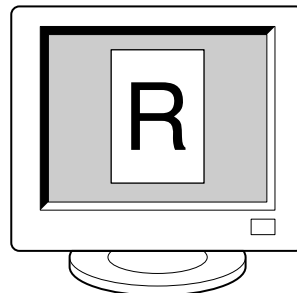
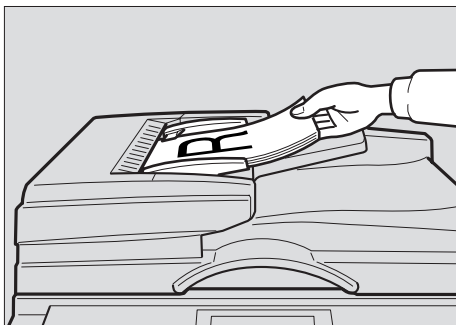

- 2 Adjust the guide on the document feeder (ADF) to the size of the original.

2-sided Scanning

- 1** Set the originals in the document feeder (ADF) with the side to be scanned first (the front side of the original) face up.

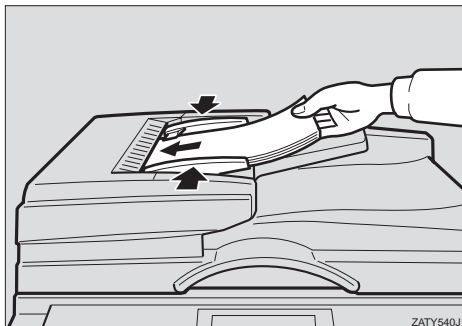

Note

- The sheets of the original should be ordered in the preferred page sequence.

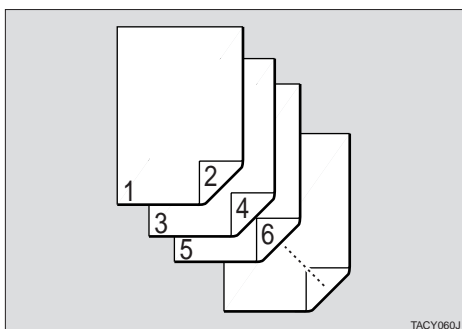

- To avoid a multi-sheet feed (in which the ADF feeds through more than one sheet at a time), shuffle the pages of the original before setting them in the document feeder (ADF).
- Set the original with the same direction of the front side as shown in the illustration. The direction of the resulting scan of the reverse side will be upside down, as shown below. However, You can rotate the direction of the resulting scan by changing the settings of DriverName;. For more information on changing the settings, see the Help that comes with Type270 TWAIN Driver Ver.2.

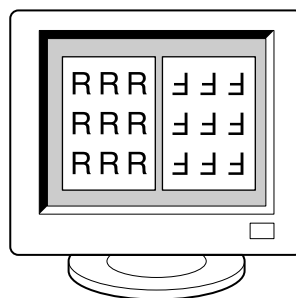
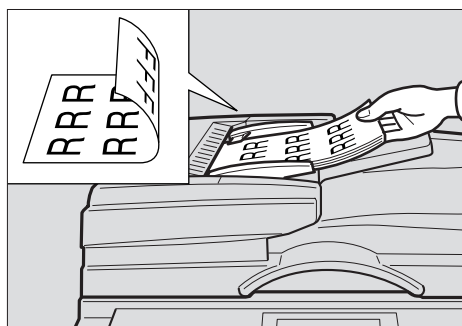

- 30 **2** Adjust the guide on the document feeder (ADF) to the size of the original.

Troubleshooting

This section explains the possible causes and the actions to take when the scanner does not scan an image in the expected manner.

Status	Cause	Action
The scanned image is dirty.	The exposure glass (platen glass) or the platen cover is dirty.	Clean the exposure glass (platen glass) or the platen cover.
The scanned image is distorted or out of position.	The original was moved while it was being scanned.	Do not move the original while it is being scanned.
	The original was not pressed flat against the exposure glass (platen glass).	Confirm that the original is pressed flat against the exposure glass (platen glass).
The scanned image is upside down.	The original was placed upside down.	Place the original in the correct direction. 🔍 Reference P.27 "Setting Originals on the Exposure Glass (Platen Glass)" P.28 "Setting Originals in the Document Feeder (ADF)"
The original image cannot be scanned.	The original was placed with the front and the back reversed.	When setting originals on the exposure glass (platen glass), place the side to be scanned face down; when setting originals in the document feeder (ADF), place the side to be scanned face up. 🔍 Reference P.27 "Setting Originals on the Exposure Glass (Platen Glass)" P.28 "Setting Originals in the Document Feeder (ADF)"
The image density has changed in the middle of the scan.	Some types of originals may cause the density to change in the middle of a scan.	Set the Erase Background to "off" and scan the original again.

The Copier Error Messages

This section describes possible causes of and actions to take for error messages displayed on the machine's operation panel. Error messages are classified into three groups: the image data settings, the copier and the Network Delivery scanner.

 **Note**

- If an error message that is not described here appears, turn the power off, and then back on again. If this does not clear the error message, take a note of the contents and number of the error message and contact your sales or service representative.

 **Reference**

If an error message appears on the display of the client computer sending a scan order, see P.35 "Type270 TWAIN Driver Ver.2 Error Messages".

5

Image Data Setting Error Messages

<p>Cannot detect original size. Check whether original is placed and select the proper size.</p>	<ul style="list-style-type: none"> • Place the original again. • Set the original size to be scanned.
<p>Invalid data size. Check the scanning resolution.</p>	<ul style="list-style-type: none"> • Reset the original size to be scanned. • Lower the resolution value. • Add the optional memory module.
<p>Memory full. Cannot continue, send the existing scanned data or delete, reset and repeat the process.</p>	<ul style="list-style-type: none"> • Reset the original size to be scanned. • Lower the resolution value. • Add the optional memory module. <p> Note</p> <ul style="list-style-type: none"> <input type="checkbox"/> This message appears when the second or later pages of the originals cannot be scanned. If you want to send the scanned pages (up to the previous page) only, press send. This procedure must be completed within about 15 minutes after the error occurs. If you press delete, all the stores data is deleted and no data is sent. Scan the remaining pages after the memory capacity is back to normal.
<p>Memory full. Cannot scan. Scanning has stopped the scanned data has been deleted.</p>	<ul style="list-style-type: none"> • Press [Exit] and delete the scanned data. • Add the optional memory module.

Copier Error Messages

Place originals in the ADF correctly.	<ul style="list-style-type: none"> The cover of the document feeder (ADF) is open. Close the cover.
ADF left in open position. Close ADF.	<ul style="list-style-type: none"> The document feeder (ADF) is open. Lower it to the correct position.
Clear misfed original(s)	<ul style="list-style-type: none"> A misfeed of the original occurred in the document feeder (ADF). Remove the misfed original.
Cannot scan due to another application currently in use.	<ul style="list-style-type: none"> The machine is using another function such as the copy function. Wait until the machine finishes using the other function.
Turn Operation Switch off then on. If error appears again call service.	<ul style="list-style-type: none"> Confirm that the scanner unit is properly connected to the network. Turn the power switch off and then on again. If you cannot clear the error message, take a note of the contents and number of the error message and contact your sales representative. ("SC4xxx" is the error number. The displayed error number differs depending on the kind of error.)

5

Network Delivery Scanner Error Messages

Address update failed. Try again?	<ul style="list-style-type: none"> Confirm that the delivery application used by the ScanRouter Station is working. There is not enough hard disk space available on the ScanRouter Station. Increase the amount of free disk space (minimum 200MB).
You have exceeded address data limit. Check the data.	<ul style="list-style-type: none"> More than 200 addresses have been registered. Reduce the number of addresses to 200 or less.
Error in sending image. Scan with the same settings and resend.	<ul style="list-style-type: none"> Confirm that the scanner unit is properly connected to the network.
Page limit exceeded, to scan remaining pages, press Exit then Start (to run as a new Job).	<ul style="list-style-type: none"> The number of pages the machine is to scan at a time exceeds the page limit. Wait until the scanned data is delivered, and then restart scanning.

You have exceeded data capacity please wait until the current data has been sent.	<ul style="list-style-type: none">• The amount of data the machine can transact at a time exceeds the data capacity. Wait until the current document data is delivered, and then restart scanning.
Cannot communicate with the server. Check the operating status and server connection.	<ul style="list-style-type: none">• Confirm that the scanner unit is properly connected to the network.

Type270 TWAIN Driver Ver.2 Error Messages

This section describes possible causes and actions to take for the error messages displayed on the computer's screen. Error messages are classified into four groups: the image data settings, scanning operation, the copier and others.

Note

- ❑ If an error message that is not described here appears, turn the power off, and then back on again. If this does not clear the error message, take a note of the contents and number of the error message and contact your sales or service representative.

Reference

If a message appears on the machine's operation panel, see P.32 *"The Copier Error Messages"*.

Image Data Setting Error Messages

[Low memory. Please quit another application.]	<ul style="list-style-type: none"> • Memory is low. Quit other currently running applications, and then restart scanning.
[Fail in creating or saving file.]	<ul style="list-style-type: none"> • There is not enough hard disk space available. Delete unnecessary files.
[Fail in saving preview image]	<ul style="list-style-type: none"> • There is not enough hard disk space available. Delete unnecessary files.
[Can not find document size. Set the original size.]	<ul style="list-style-type: none"> • Place the original again. • Set the original size to be scanned.
[Frame memory shortage. Can not scan detected size.]	<ul style="list-style-type: none"> • Reset the original size to be scanned. • Lower the resolution value.

Scanning Operation Error Messages

[Set the original on ADF.]	<ul style="list-style-type: none"> • Load originals in the document feeder (ADF) properly.
[Stop Scanning.]	<ul style="list-style-type: none"> • Scanning has stopped.

Copier Error Messages

[Power off or cable problem. Check the scanner.]	<ul style="list-style-type: none"> • Confirm that the scanner unit is properly connected to the network. • Confirm that the power switch of the machine is not off.
[Can not use Scanner. Check connection of Scanner.]	<ul style="list-style-type: none"> • Confirm that the scanner unit is properly connected to the network. • Confirm that the power switch of the machine is not off.
[Scanner not ready. Check the scanner.]	<ul style="list-style-type: none"> • The cover of the document feeder (ADF) is open. Close the cover. • The document feeder (ADF) is open. Lower it to the correct position.
[Scanner error.]	<ul style="list-style-type: none"> • Confirm that the cover of the document feeder (ADF) is not open.
[Clear Misfeed(s) in ADF.]	<ul style="list-style-type: none"> • A misfeed of the original occurred in the document feeder (ADF). Remove the misfed original.
[Check power switch.]	<ul style="list-style-type: none"> • Confirm that the cover of the document feeder (ADF) is not open. • Confirm that the scanner unit is properly connected to the network. • Confirm that the machine is not in the Low-Power Mode. If the Low-Power Mode is on, cancel it by pressing [Energy Saver].
[Scanning function is unavailable. Call your service representative.]	<ul style="list-style-type: none"> • An error message that cannot be cleared occurred in the machine. Contact your service representative.

Other Error Messages

[Scanner error.]	<ul style="list-style-type: none"> • Confirm that the Ethernet board has been properly detected by Windows. • Confirm that your computer has been configured to use the TCP/IP. ⇒ P.21 <i>"Installing/Uninstalling Type270 TWAIN Driver Ver.2"</i> • Confirm that the Ethernet cable is properly connected to the network.
------------------	---

[Can not save in default file.]	<ul style="list-style-type: none">• The data cannot be saved in the default file.• Save the data in a different file.
[Cannot connect to the scanner. Check the network address and mask settings.]	<ul style="list-style-type: none">• Access mask is configured. Contact your network or scanner administrator.
[Please wait. Another user is using the scanner.]	<ul style="list-style-type: none">• Another user is using the machine to scan originals. Wait for a while before attempting to access the machine.
[Communication error on the network.]	<ul style="list-style-type: none">• The machine is using another function such as the copy function. Wait until the machine finishes using other functions. Wait for a while before attempting to access the machine.

Status Messages

The following table shows the status messages on the panel display of the machine and its conditions when used as a scanner.

Status	Message	Descriptions
While standing by.	Ready	<ul style="list-style-type: none"> • Input from all of the function keys is accepted. • Input from the [Interrupt] key is accepted. • Interrupt requests from other functions are accepted. • The System Reset function works.
Accessing the machine from a client on the network.	Connecting	<ul style="list-style-type: none"> • Input is not accepted from any of the function keys. • Input from the [Interrupt] key is not accepted. • Interrupt requests from other functions are not accepted. • The System Reset function does not work.
During continuous scanning (while scanning originals placed on the document feeder (ADF)). While transferring the scanned data to a computer.	Scanning	<ul style="list-style-type: none"> • Input is not accepted from any of the function keys. • Input from the [Interrupt] key is not accepted. • Interrupt requests from other functions are not accepted. • The System Reset function does not work.
While feeding originals using the document feeder (ADF).	Please wait.	<ul style="list-style-type: none"> • Input is not accepted from any of the function keys. • Input from the [Interrupt] key is not accepted. • Interrupt requests from other functions are not accepted. • The System Reset function does not work.

System Settings

Accessing the User Tools (System Settings)

This section is for the key operators in charge of this machine. You can change or set the machine's default settings.

Preparation

After using the user tools, be sure to return to Copy mode.

The settings are not canceled even if the operation switch is turned off or **[Clear Modes]** is pressed.

Reference

For information on Copy, Fax, and Printer User Tools, see the appropriate reference manual.

1 Press **[User Tools/Counter]**.

The User Tools Main Menu appears.

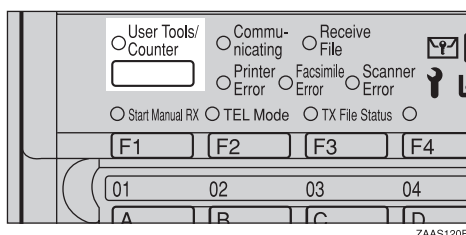

2 Enter **[1]** with the number keys.

The system settings menu appears.

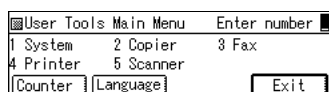

Note

- Press **[Language]** to switch the display language.

3 Search for the desired menu with **[↓Next]** or **[↑Prev.]**. Then enter its number with the number keys.

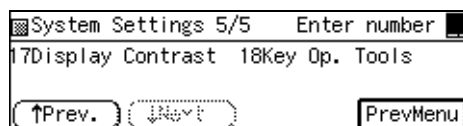
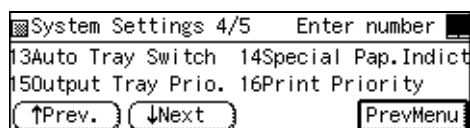
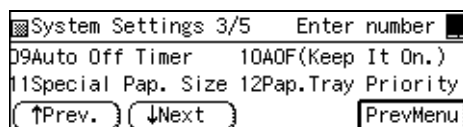
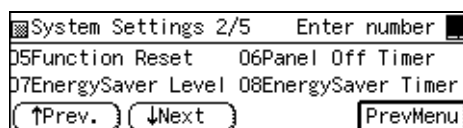
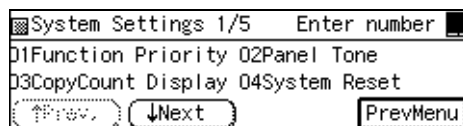

Note

- [↓Next]**: Press to go to the next page.
- [↑Prev.]**: Press to go back to the previous page.

4 Change the settings by following the instructions on the panel display. Then press **[OK]**.

Note

- [OK]:** Press to set the new settings and return to the previous menu.
- [Cancel]:** Press to return to the previous menu without changing any data.

Exiting from the User Tools

1 After changing the user tools settings, press **[PrevMenu]**.

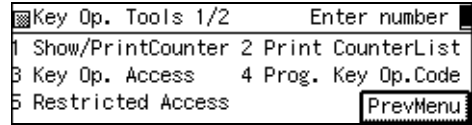

2 Press **[Exit]** to return to Copy mode.

Settings You Can Change with the User Tools

Note

- The setting items described below are required for configuring the scanner unit. For information on other setting items, see the “System setting Reference.”

Reference

For more information on how to access the user tools, see P.39 “Accessing the User Tools (System Settings)”.

System Settings

Menu	Description
01. Function Priority	<p>You can set the mode to be displayed immediately after the operation switch is turned on or System Reset mode is turned on.</p> <p> Note</p> <p><input type="checkbox"/> Default: <i>Copier</i></p>
05. Function Reset	<p>How long the machine waits before switching to the default mode if no operation has been performed after an operation was finished. The time can be set from 3 to 60, or Instant.</p> <p> Note</p> <p><input type="checkbox"/> Default: <i>10 seconds</i></p>

Relationship Between Resolution and Scanning Area

The resolution and scanning area are inter-related. As the resolution increases, the area that can be scanned decreases, and vice-versa.

Note

- The size of the scanning area in the table is standard.
- The **[Colors/Gradients]** setting will affect the relationship between the resolution and the scanning area.

Limitation

- The maximum scanning area may differ depending on the memory capacity of the machine and image compressing method.

Binary / Halftone

5

❖ Setting originals on the exposure glass (platen glass)

Scanning Area	Resolution (dpi)															
	100	200	300	400	500	600	700	800	900	1000	1100	1200	1300	1400	1500	1600
A3	235	943	2121	3772	5893	8487	-	-	-	-	-	-	-	-	-	-
A4	117	470	1061	1886	2945	4247	5779	7545	-	-	-	-	-	-	-	-
A5	58	234	527	939	1469	2116	2876	3759	4758	5877	7113	8467	-	-	-	-
A6	28	117	264	468	733	1058	1437	1879	2381	2935	3554	4233	4963	5759	6614	7519
B4	176	705	1591	2826	4422	6364	-	-	-	-	-	-	-	-	-	-
B5	87	353	794	1414	2208	3183	4329	5659	7167	-	-	-	-	-	-	-
B6	43	174	394	702	1098	1582	2154	2815	3564	4401	5325	6339	7440	-	-	-
11×17in	227	913	2051	3652	5702	8217	-	-	-	-	-	-	-	-	-	-
Legal 8 1/2×14in	144	579	1304	2324	3629	5225	7110	-	-	-	-	-	-	-	-	-
Letter 8 1/2×11in	113	455	1024	1826	2852	4105	5587	7304	-	-	-	-	-	-	-	-
5 1/2×8 1/2in	56	227	512	913	1423	2051	2794	3652	4616	5702	6902	8217	-	-	-	-

- Value : data in KB
- — : unavailable combination

❖ Setting originals on the ADF

Scanning Area	Resolution (dpi)															
	100	200	300	400	500	600	700	800	900	1000	1100	1200	1300	1400	1500	1600
A3	235	943	2121	3772	5893	8487	-	-	-	-	-	-	-	-	-	-
A4	117	470	1061	1886	2945	4247	5779	7545	-	-	-	-	-	-	-	-
A5	58	234	527	939	1469	2116	2876	3759	4758	5877	7113	-	-	-	-	-
A6	28	117	264	468	733	1058	1437	1879	2381	2935	3554	-	-	-	-	-
B4	176	705	1591	2826	4422	6364	-	-	-	-	-	-	-	-	-	-
B5	87	353	794	1414	2208	3183	4329	5659	7167	-	-	-	-	-	-	-
B6	43	174	394	702	1098	1582	2154	2815	3564	4401	5325	6339	-	-	-	-
11×17in	227	913	2051	3652	5702	8217	-	-	-	-	-	-	-	-	-	-
Legal 8 1/2×14in	144	579	1304	2324	3629	5225	7110	-	-	-	-	-	-	-	-	-
Letter 8 1/2×11in	113	455	1024	1826	2852	4105	5587	7304	-	-	-	-	-	-	-	-
5 1/2×8 1/2in	56	227	512	913	1423	2051	2794	3652	4616	5702	6902	8217	-	-	-	-

- Value : data in KB
- — : unavailable combination

Gray Scale

❖ Setting originals on the exposure glass (platen glass)

Scanning Area	Resolution (dpi)															
	100	200	300	400	500	600	700	800	900	1000	1100	1200	1300	1400	1500	1600
A3	1887	7550	-	-	-	-	-	-	-	-	-	-	-	-	-	-
A4	942	3774	8493	-	-	-	-	-	-	-	-	-	-	-	-	-
A5	469	1880	4233	7524	-	-	-	-	-	-	-	-	-	-	-	-
A6	234	939	2116	3761	5877	8466	-	-	-	-	-	-	-	-	-	-
B4	1414	5662	-	-	-	-	-	-	-	-	-	-	-	-	-	-
B5	706	2831	6369	-	-	-	-	-	-	-	-	-	-	-	-	-
B6	351	1409	3171	5639	8811	-	-	-	-	-	-	-	-	-	-	-
11×17 in	1826	7304	-	-	-	-	-	-	-	-	-	-	-	-	-	-
Legal 8 1/2×14 in	1162	4648	-	-	-	-	-	-	-	-	-	-	-	-	-	-
Letter 8 1/2×11 in	913	3652	8217	-	-	-	-	-	-	-	-	-	-	-	-	-
5 1/2×8 1/2 in	456	1826	4108	7304	-	-	-	-	-	-	-	-	-	-	-	-

- Value : data in KB
- — : unavailable combination

◆ Setting originals on the ADF

Scanning Area	Resolution (dpi)															
	100	200	300	400	500	600	700	800	900	1000	1100	1200	1300	1400	1500	1600
A3	1887	7550	-	-	-	-	-	-	-	-	-	-	-	-	-	-
A4	942	3774	8493	-	-	-	-	-	-	-	-	-	-	-	-	-
A5	469	1880	4233	-	-	-	-	-	-	-	-	-	-	-	-	-
A6	234	939	2116	-	-	-	-	-	-	-	-	-	-	-	-	-
B4	1414	5662	-	-	-	-	-	-	-	-	-	-	-	-	-	-
B5	706	2831	6369	-	-	-	-	-	-	-	-	-	-	-	-	-
B6	351	1409	3171	-	-	-	-	-	-	-	-	-	-	-	-	-
11×17 in	1826	7304	-	-	-	-	-	-	-	-	-	-	-	-	-	-
Legal 8 1/2×14 in	1162	4648	-	-	-	-	-	-	-	-	-	-	-	-	-	-
Letter 8 1/2×11 in	913	3652	8217	-	-	-	-	-	-	-	-	-	-	-	-	-
5 1/2×8 1/2 in	456	1826	4108	-	-	-	-	-	-	-	-	-	-	-	-	-

- Value : data in KB
- — : unavailable combination

When Using DHCP

Note the following points when using DHCP (Dynamic Host Configuration Protocol).

Supported Systems

Windows NT Server 4.0 can be configured as a DHCP server.

Configuring the scanner with a Reserved IP Address

To always assign the same IP address, configure a reserved IP address using the DHCP server.

Note

- When multiple DHCP servers are used, reserve the same IP address with each DHCP server. The Network Interface Board needs to receive information from the DHCP server that it contacts.

Follow these steps to configure the scanner with a reserved IP address.

- 1** Start the DHCP manager.
- 2** Select the scope that will be used, and on the **[Scope]** menu, click **[Reservation]**.
- 3** Type the IP address into **[IP Address]**.
- 4** Type the MAC address of the Network Interface Board into **[Unique Identifier]**.

Note

- Do not use hyphens to separate the numbers.
- If you do not know the MAC address, it can be found on the configuration page printed by the printer.

- 5** Type a name and comment into the **[Client Name]** box and the **[Client Comment]** box.

Note

- For more information on client names, see P.45 “*The Others*”.

- 6** Click **[Add]**.

An IP address is reserved.

- 7** Click **[Close]** to close the dialog box.

The Others

- When you click **[Active Lease]** on the **[Scope]** menu of DHCP manager, a list of client leases appears. When the reserved IP address is not active, the name of the reservation is the name entered in the client Name field of the Add Reserved Clients dialog box. When the reserved IP address becomes active, the client name changes to the client name configured by the Network Interface Board. Only the first 13 letters of the scanner name appear here.
- When the DHCP server does not assign an IP address, the network interface of this scanner unit uses 11.22.33.44 as a temporary IP address. ⇒ P.9 “*Setting Up the Network Environment*”
- Because 11.22.33.44 is a special IP address, you cannot scan using this address.
- When using DHCP relay agent in a network environment that uses a dial up router to connect to the network interface of this scanner unit, an increase in communication fees can occur.

Assigning an IP Address with ARP+PING

Using TCP/IP, you can assign the IP address using ARP and PING. The following example is for a BSD UNIX workstation (SunOS 4.x).

Preparation

ARP+PING should be set to active on the network boot configuration before assigning the IP address using ARP+PING. For more information on setting it to active, see the P.11 “*Network Setting Items*”.

1 Log on to the workstation as root.

2 Use the `arp` command to assign the IP address to the MAC address of the Network Interface Board.

```
# arp -s 192.168.15.16
      00:00:74:62:5C:65
```

Note

□ 192.168.15.16 is the IP address, and 00:00:74:62:5C:65 is the MAC address.

3 Assign the IP address using the `ping` command.

```
# ping 192.168.15.16
```

4 Use the `ping` command again to confirm the address.

```
# ping 192.168.15.16
```

If the address has been configured correctly, the following message appears.

```
192.168.15.16 is alive
```

If the address has been configured incorrectly, the following message appears.



```
no anser from 192.168.15.16
```

How to Confirm the MAC Address

The MAC address (Ethernet address) of the Network Interface Board is required in order to use ARP and PING to assign the IP address.

The MAC address can be seen on the scanner configuration page.

Specifications

Scanning method	One dimension solid scanning system through CCD
Image sensor type	CCD image sensor
Original types	Sheet, Book, Object
Interface	<p>Ethernet (10BASE-T or 100BASE-TX)</p> <p> Note</p> <p><input type="checkbox"/> Be sure to use category 5 STP cable.</p>
Maximum original size	A3  , 11"×17" 
Resolution	<p>600dpi</p> <p>❖ Placing originals on the exposure glass (platen glass)</p> <ul style="list-style-type: none"> • For monochrome 256-value (gray scale) scanning, a resolution of 100 to 600 dpi can be set (in units of 4 dpi). • For monochrome or monochrome (half tone) scanning, a resolution of 100 to 2400 dpi can be set (in units of 1 dpi). <p>❖ Loading originals in the document feeder</p> <ul style="list-style-type: none"> • For monochrome 256-value (gray scale) scanning, a resolution of 100 to 300 dpi can be set (in units of 4 dpi). • For monochrome or monochrome (half tone) scanning, a resolution of 100 to 1200 dpi can be set (in units of 4 dpi).

INDEX

A

ARP+PING, 46

D

DHCP, 45

E

Error Messages

canning Operation Error Messages, 35

Image Data Setting Error Messages, 35

Other Error Messages, 36

The Copier Error Messages, 36

F

Function Priority, 40

Function Reset, 40

H

Hardware Environments, 20

Help Files, 22

I

Installing

Type270 TWAIN Driver Ver.2, 21

Windows 95, 21

Windows 98, 21

WindowsNT3.51, 24

WindowsNT4.0, 23

IP address, 46

M

MAC address, 46

R

Readme.txt, 22

S

Scanner Function, 25

Software Environments, 20

T

The Copier Error Messages, 32

Type270 TWAIN Driver Ver.2, 19, 21

Type270 TWAIN Driver Ver.2 Error Mes-
sages, 35

U

Uninstalling

Type270 TWAIN Driver Ver.2, 21

Windows95, 22

WindowsNT3.51, 24

WindowsNT4.0, 23

Uninstalling

Windows98, 22